

Quick Start Guide

LIFETIME WARRANTY
support@sineaudio.com.cn

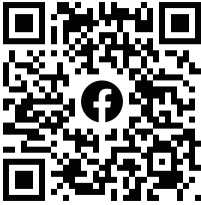

Learn More About Us!



Join us on Facebook



Unlock Lifetime Warranty-
Scan within 7 Days



www.youtube.com/@Saiyin-Riowois

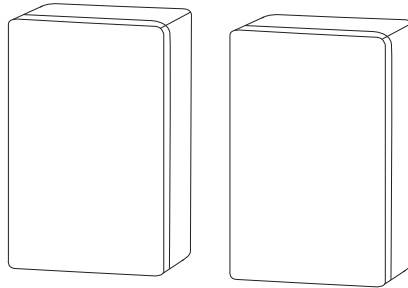

On Wall Passive Speakers

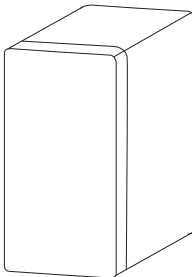

Passive Speakers



Center Channel Speaker

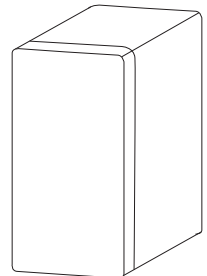

Passive Speakers

Step 1: Carefully Unpacking the Carton and Confirm that the following parts are Included

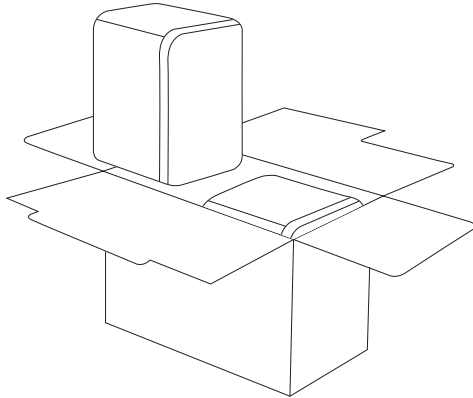

One Pair Passive Bookshelf Speakers

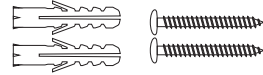

Wall Mount Kit

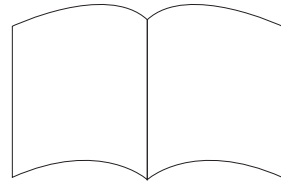

Quick Start Guide

Step 2: Amplifier or Receiver and Speaker Wire are Required

Caution! Please choose the appropriate amplifier or receiver according to the output power of your passive speakers

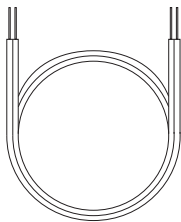

Speaker Wire (Not Included)
16-20 Gauge is Recommended

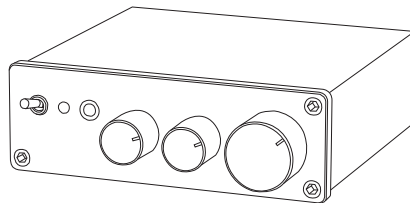

Amplifier or Receiver (Not Included)

Amplifier or Receiver is Required

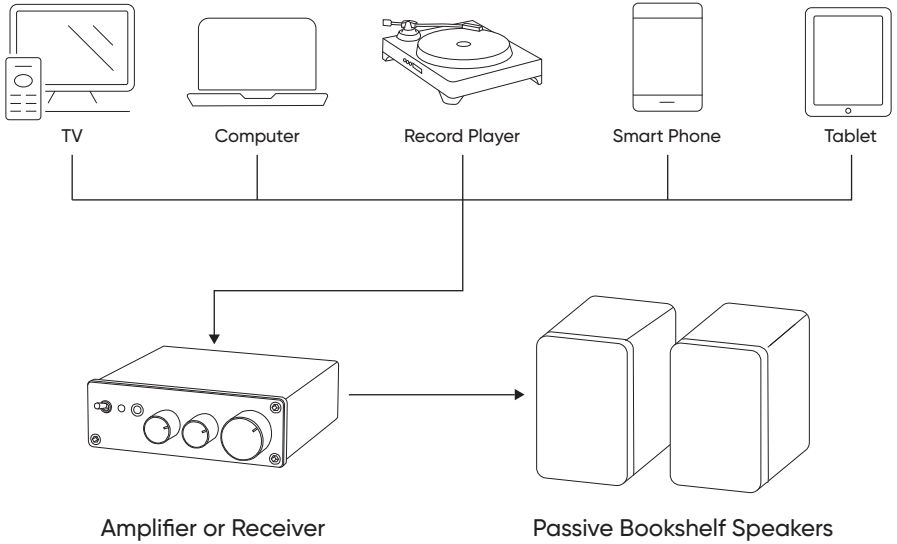

Connecting the Passive Speakers with Amplifier via Speaker Wire

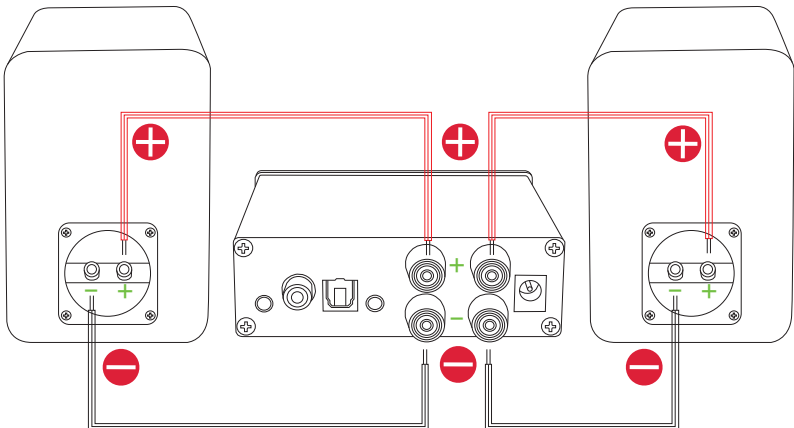

Speaker Placement in Surround Sound System

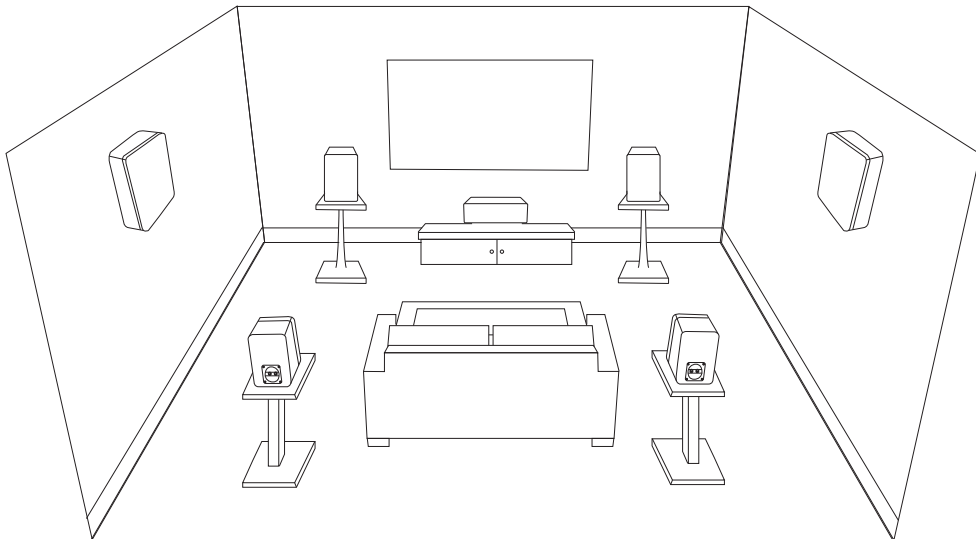

Before connecting, turn down the volume on your amplifier or receiver, set the equalizer (EQ) to flat, and turn off the amplifier or receiver.

Once the connection is complete, turn on the amplifier or receiver, slowly increase the volume to a comfortable level, and adjust the equalizer (EQ) to achieve the desired sound quality.

Key Reminders When Choosing an Amplifier:

1. Ensure the amp's RMS/channel rating matches your speakers' recommended.
2. Power range and nominal impedance. Avoid underpowering or massive overpowering.

For best sound quality, we recommend using high-quality copper speaker wire.

How to connect:

1. Spring Clip Terminals: Strip the wire, twist the strands tightly, and press firmly into the clip.
2. Binding Post Terminals: Strip the wire and twist tightly for a bare-wire connection, or use a U-type connector for the most secure fit.

Pro Tip: Always twist the exposed copper into a tight bundle. Loose strands can cause short circuits or degrade audio quality.

Note: For clearer dialogue and less boom, use the provided sponges to plug the bass reflex port.

The sponges are shipped compressed. Simply let them sit for a few days, and they'll spring back to their round shape.