

Quick Start Guide

LIFETIME WARRANTY
support@sineaudio.com.cn



Learn More About Us!



Join us on Facebook



Unlock Lifetime Warranty
-Scan within 7 Days



www.youtube.com/@Saiyin-Riowois

Powering on the Speakers -----P1~P2

Setting Up the Speakers with TV via Optical Cable -----P3~P4

Setting Up the Speakers with TV via AUX Cable-----P5

Connecting to the Record Player Via AUX Cable-----P6

Connecting to Source Device via Bluetooth-----P7

Remote Compatibility -----P8

Troubleshooting -----P9~P11

Powering on the Speakers

Step 1: Carefully Unpacking the Carton and Confirm that the Following parts are Included



Speaker Wire
(Only for model
DS6801S, DS6701)

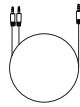

Audio Cable

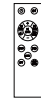

Remote

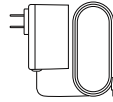

Power Adapter

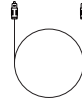

Optical Cable

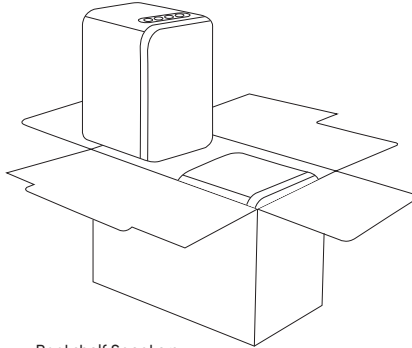

Bookshelf Speakers
(One Active Speaker, One Passive Speaker)

Step 2: Connecting the Active and Passive Speakers via the Speaker Cable

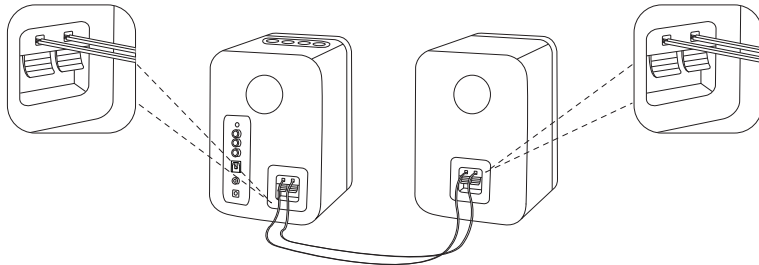

(DS6701, DS6801S)

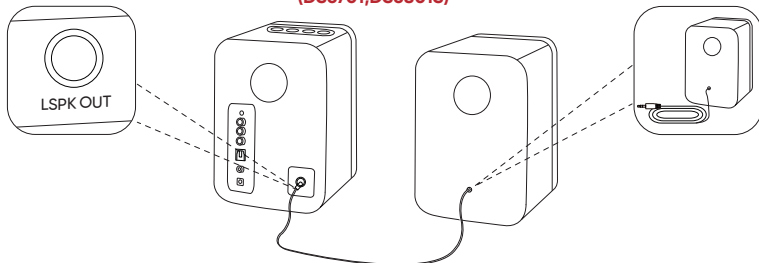

(DS6701S)

Powering on the Speakers

Step 3: Plugging in the Power Adapter

Speakers enter standby status and the indicator lights on red

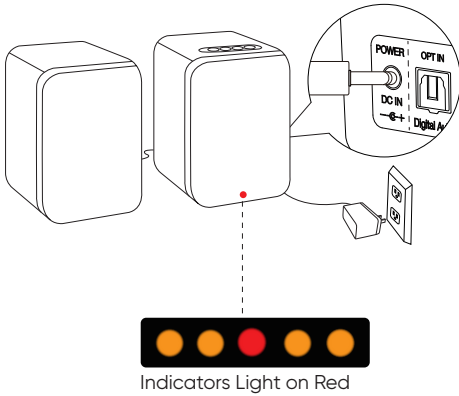

Step 4: Powering on the Speakers and Entering into Bluetooth Mode

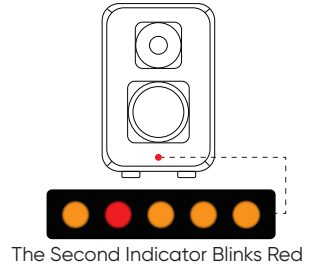
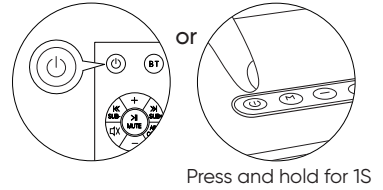

Step5: Selecting the Appropriate Method to Connect the Speakers to your Source Device Based on its Outputs

(Optical Preferred for TV)

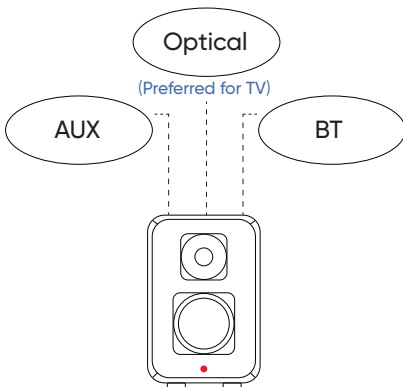

Setting Up the Speakers with TV via Optical Cable

Step 1: Removing the Protective Caps from both Ends of the Optical Cable

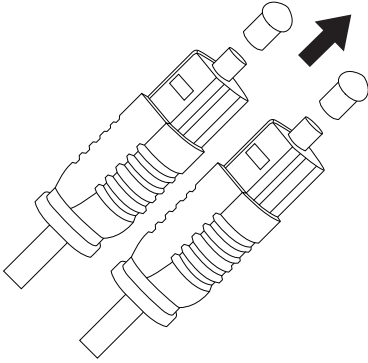

Step 2: Connecting with Optical Cable

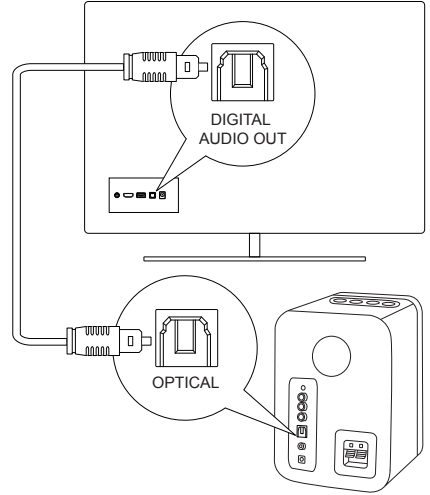

Step 3: Switching the Speakers to Optical Mode

Press M button on top of the main speaker or OPT button on remote to switch to OPT mode.

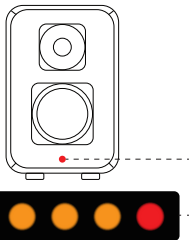
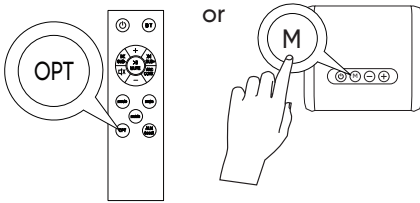

The Fifth Indicator Lights on Red

Step 4: Set TV Sound Output to Optical

Settings > Sound > Sound Output > Optical/
External speakers

Different TV brands have varying setup procedures, please refer to your TV's owner's guide for the appropriate setup instructions.

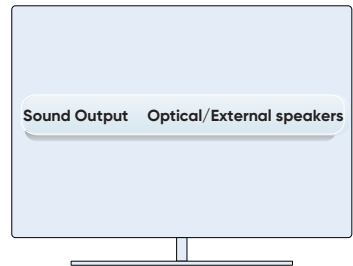

Setting Up the Speakers with TV via Optical Cable

Step 5: Changing Digital Audio Output format to PCM/Stereo/Non Surround Sound

Settings > Sound > Expert Settings > Digital Output Audio Format > PCM/Stereo Sound/Non Surround Sound . Different TV brands have varying setup procedures, please refer to your TV's owner's guide for the appropriate setup instructions.

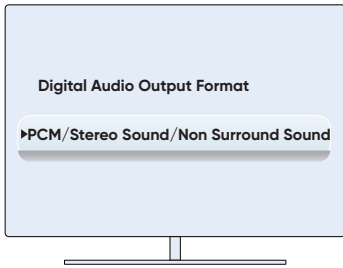

Step 6: Disable the Dolby/DTS of TV

To avoid silent or noisy output from the speakers, please disable the Dolby/ DTS on your TV.

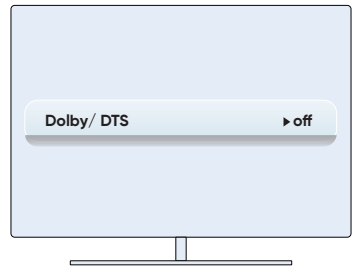

Step 7

For streaming devices (e.g. Roku Box, Fire Stick, etc), you must also set the audio output format to "PCM/Stereo/Non-Surround" in the settings. Otherwise, there may be static noise or no sound at all

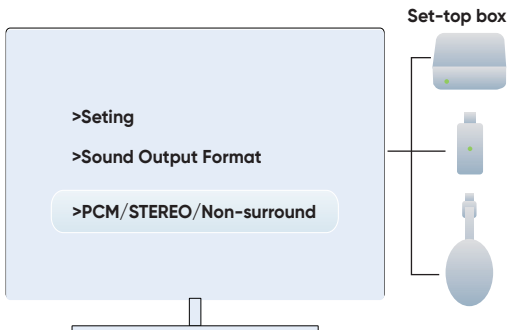

Step 8: Compatible with Fire TV remote

If you are using a Fire TV stick, follow these steps to control the speakers with your TV remote: Equipment Control>Manage Equipment>Soundbar>Change Soundbar>Meidong>Input is not listed .

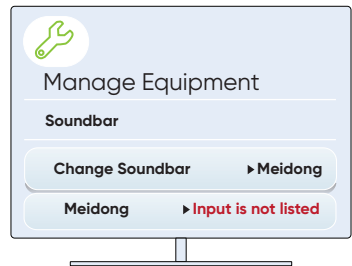

Setting Up the Speakers with TV via AUX Cable

Step 1: Connecting the RCA Cable

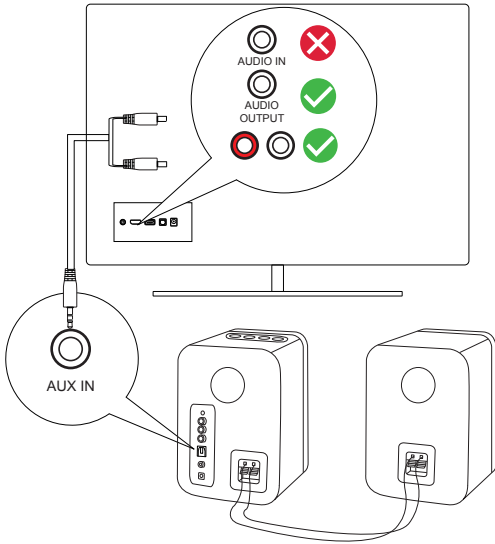

OR

Step 1: Connecting the RCA Cable

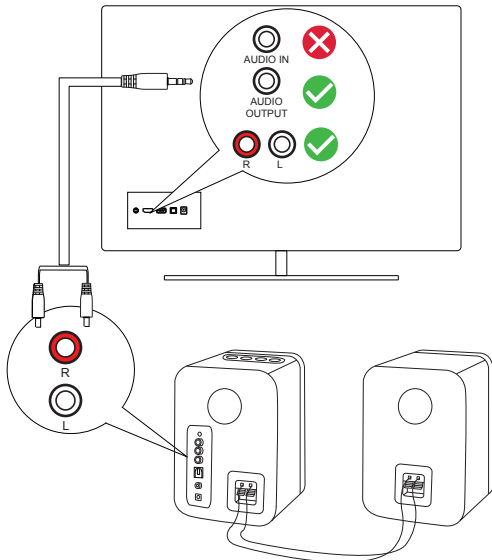

Step 2: Switching the Speakers to AUX (RCA) Mode

Pressing M button on top of the main speaker or AUX button on remote to switch to AUX mode.

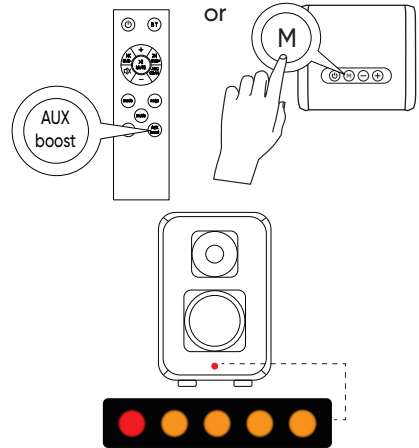

The First Indicator Lights on Red

Step 3: Setting TV Sound Output to External Speakers

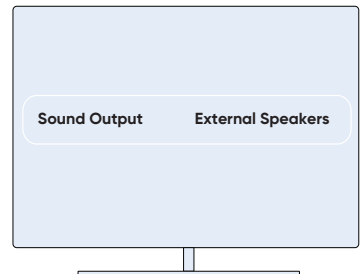

Connecting to the Record Player Via AUX Cable

Step 1: The Speakers can be Connected with Record Player Directly via LINE OUT, while a Preamplifier is Required if the Record Player has only PHONO output.

Please note that the turntable may produce noise when the cartridge is raised, which is caused by the turntable itself not by the speakers.

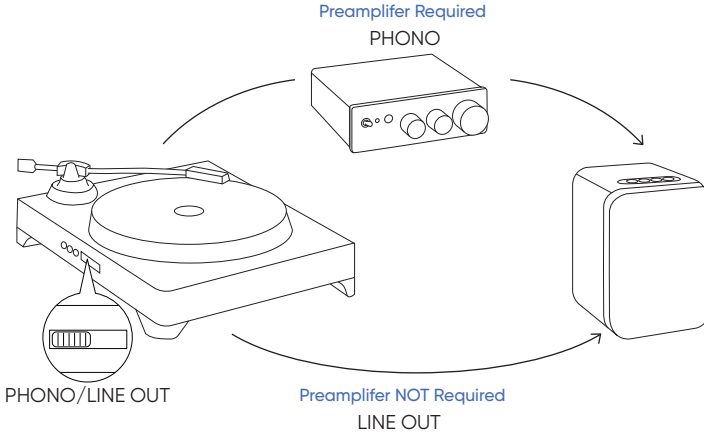

Step 2: Connecting the Record Player via the Audio Cable

Step 3: Switching the speakers to AUX Mode

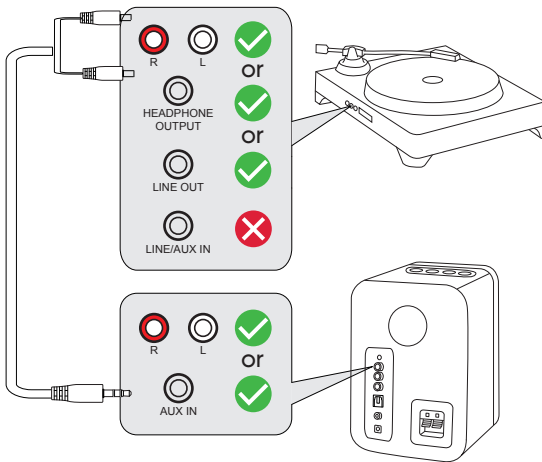

Pressing M button on top of the main speaker or AUX button on remote to switch to AUX mode.

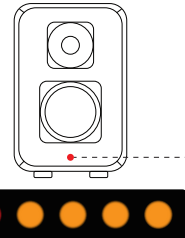
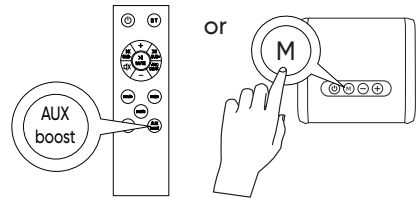

The First Indicator Lights on Red

To use your turntable with our Bluetooth speakers:

*Your turntable must have Bluetooth transmitter/output(for connecting Bluetooth speakers and headphones.

*If your turntable only has a Bluetooth receiver/input (like most built-in speaker turntables for connecting mobile phones), it won't work with our speakers.

Connecting to Source Device via Bluetooth

Please make sure that your audio source devices are built with Bluetooth transmitter/output like smartphones, TVs and PCs, rather than a Bluetooth receiver/input like Bluetooth headphones, record players with speakers and Bluetooth speakers etc.

Step 1: Switch the Speakers to Bluetooth Mode

Pressing M button on top of the main speaker or BT button on remote to switch to Bluetooth mode.

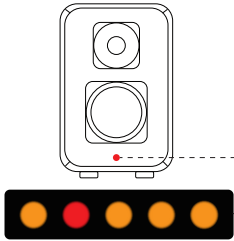
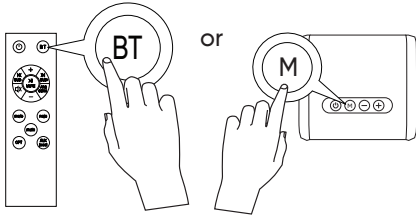

The Second Indicator Blinks Red

Step 2: Connecting to the Source Device via Bluetooth

Open your device's Bluetooth settings and select SineAudio DSXXXX V1.X to connect with the Speakers.

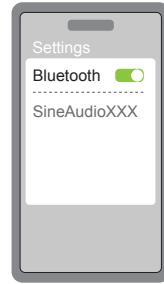

33feet(10M)

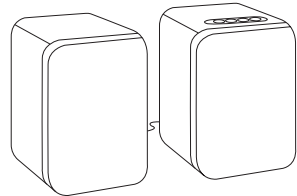

Step 3: Indicator Light Instructions

The orange light flashes quickly means bluetooth is ready for connection(for model DS6701NP,DS6701UP).
The red light flashes quickly means bluetooth is ready for connection(for other models).

The orange or red light flashes slowly means bluetooth is connected while no audio is being played.

Step 5: Disconnect Bluetooth Quickly

If you want to connect another Bluetooth device, please press and hold BT button or M button on speakers for one second to disconnect bluetooth from the current device.

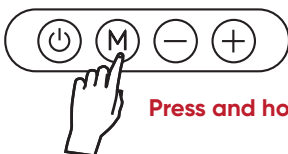

Press and hold 2S

Step 4: If Audio and Video Out of Sync

If the audio is not synchronized with the video in Bluetooth connection mode, you can try adjusting the audio output delay in your TV settings. (Depends on your TV)

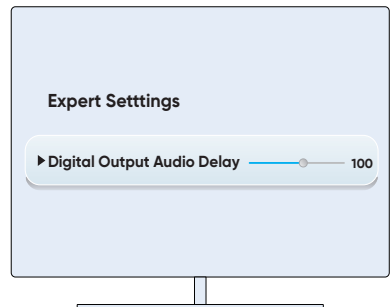

(Refer to your TV's manual for more information)

Step 6: Please max the volume of TV or other audio sources, and then adjust the volume of speakers

Remote Compatibility

(Batteries Not Included)

1: How to Pair Fire TV Remote with Speakers Remote

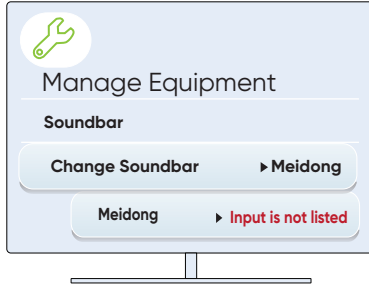

If you are using a Fire TV stick or Fire TV cube, follow these steps to control the speakers with your TV remote:

Set>Equipment Control>Manage Equipment>Soundbar>Change Soundbar>Meidong>Input is not listed

If your speaker automatically switches from the current connection mode to other modes after successful pairing with Fire TV/Stick, please follow these steps to resolve the issue :

Go to Settings > Equipment Control > Manage Equipment > Fire TV > Soundbar Input> None Selected

2: Remotes compatible with Roku box or Roku TVs are provided for free

Please contact us via after sales email support@sineaudio.com.cn and let us know which remote you need (remote for Roku TV or Roku box) and the brand of your TV.

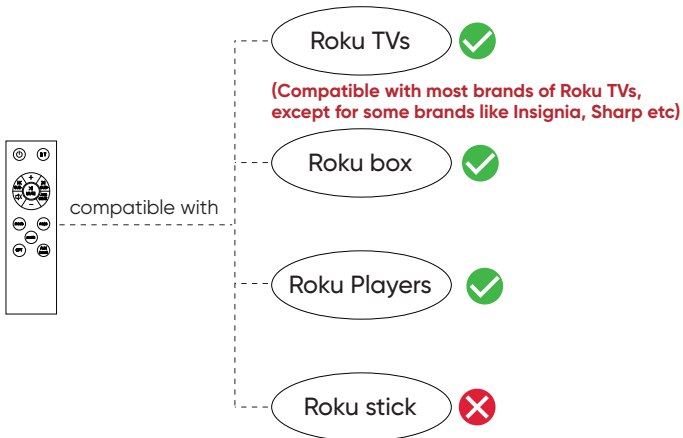

3: The remote control is compatible with Google Chromecast Remote.

Setting > Remote Accessories > Set up Remote Buttons >Add device > Soundbar >Saiyin

The remote control is compatible with **GE UltraPro and Philips universal remotes** that support code list 6 (code: 3106)

The remote control is also compatible with **RCA universal remote** that Revision Number is R341U1 (code: 87164)

Make sure your Universal Remote Control supports soundbar (speakers) and select the correct model and version. Please contact your Universal Remote Control seller for details

Troubleshooting

1: It is recommended that the volume of the source device set greater than 50%, and then adjust the volume of the speakers.

The Built-in speakers of turntable may not turn off When our speakers are connected to the Line Out of the turntable. However, the Built-in speakers of turntable will turn off automatically when our speakers are connected to the turntable via Headphone Out.

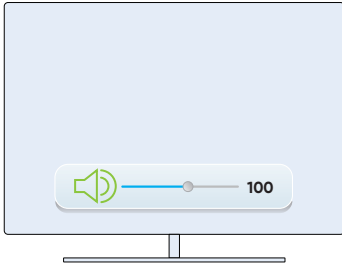

2: Static and Noise

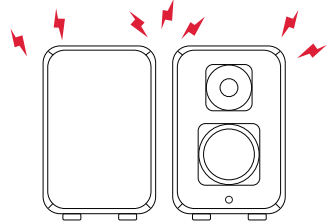

Please note that the turntable may produce noise when the cartridge is raised, which is caused by the turntable itself not by the speakers.

When there is noise after the speaker is connected to the TV via optical connection:

① Speakers does not support Dolby and DTS, please kindly disable Dolby and DTS on both of your TV and set-top box like Roku box, Fire Stick etc.

② Please try setting digital audio output format to PCM/Stereo Sound/Non-surround.

③ Select external speakers or turn off the TV speakers.

When there is noise after the speaker is connected to other devices via AUX connection.

① In order to reduce the bottom noise at low volume, please do not minimize the volume of the audio source, it is recommended that the volume of the audio source set greater than 50%, and then adjust volume of the speakers.

② Make sure that the cables are fully and properly plugged into audio source and speakers.

③ Please note when connecting with an audio cable:
1. Dirty or rusty audio output ports on the TV may cause noise, low volume, or no sound.
2. Improperly inserted or loose audio plugs may also cause noise, low volume, or distortion.

3: Can't Power On

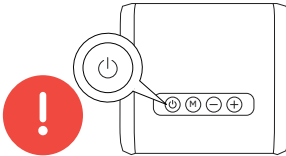

① If the speakers will not power on, please check whether the power-on button on the main speaker is stuck, or the power adapter is properly plugged into socket.

② Please contact us via after sales email: support@sineaudio.com.cn

Troubleshooting

4: Remote Stops Working

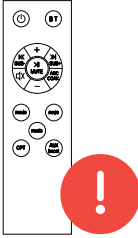

- ① Please contact us via: (support@sineaudio.com.cn) to get a free replacement remote control. (The remote does not come with batteries)
- ② The IR code of the remote control is not compatible with universal remotes or TV remotes. (The remote is compatible with Fire TV remote by choosing "Meidong" as brand of speakers).

6: Sound Quality Issues



If you feel the bass is too heavy or the vocals are not enough, press the music or news button on the remote control, or you can plug the **bass-reflex hole with a sponge**.

If distortion or sound quality problems occur, please contact with our customer service in time.

7: Stops working

The product comes with a complimentary one-year replacement policy.

If you experience any issues or if the product you received stops working within a year, please reach out to our customer service team to get a free replacement.
support@sineaudio.com.cn

5: Bluetooth Connection Issues



- ① Please make sure the speakers are not connected with any other Bluetooth devices. If the speakers are connected with smart phone via bluetooth, you will have to press and hold BT on remote for one second to disconnect and then connect with other device again.
- ② More problems please contact us via: **support@sineaudio.com.cn**
- ③ Optical cable is preferred to connect with your TV as Bluetooth connection may cause audio delay.
- ④ If the Pause/Start button is not working under Bluetooth mode, it is probably due to that the source devices do not support Bluetooth AVCRP protocols.

8: Three Sound Effects

	Treble	Vocal	Bass	Virtual Surround
Movie	+	-	Deep	++
Music	-	+	Powerful	+
News	-	++	Weak	-

Three sound effects are designed for three different scenarios to ensure that these effects sound good in their respective applications.

We minimized the differences between them because if the differences were significant, it could result in either low volume due to attenuation or high distortion due to excessive enhancement.

If you have any comments or suggestions, please contact us, we will continue to optimize and improve our sound algorithms!
support@sineaudio.com.cn

Troubleshooting

9: Speakers Not Working Properly

Issue: The speaker input mode automatically switches when controlled by the Fire TV/stick remote

Solution: Go to Settings > Equipment Control > Manage Equipment > Fire TV > Soundbar Input> None Selected

The product comes with a complimentary one-year replacement policy.

If you experience any issues or if the product you received stops working within a year, please reach out to our customer service team to get a free replacement.

support@sineaudio.com.cn