

# Quick Start Guide

**WE ARE READY TO HELP**

[support@sineaudio.com.cn](mailto:support@sineaudio.com.cn)



**Learn More About Us!**

Setting Up Videos:

[www.youtube.com/@Saiyin-Riowois](https://www.youtube.com/@Saiyin-Riowois)



[sineaudio.com.cn](http://sineaudio.com.cn)

Powering on the Soundbar-----P1

Optical Connection -----P2~P3

AUX Connection -----P4

Bluetooth Connection -----P5

Remote Compatibility -----P6

Troubleshooting -----P7~P8

# Power on the Soundbar

**Step 1: Carefully unpacking the carton and confirm that the following parts are included**

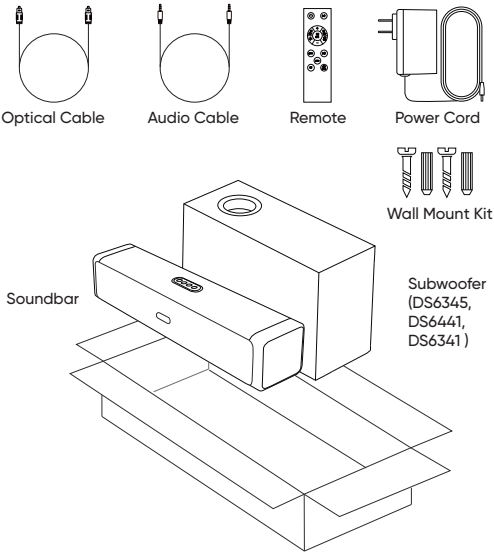

**Step 2: Connecting the power supply**

The soundbar will enter standby mode and the indicator light will turn red.

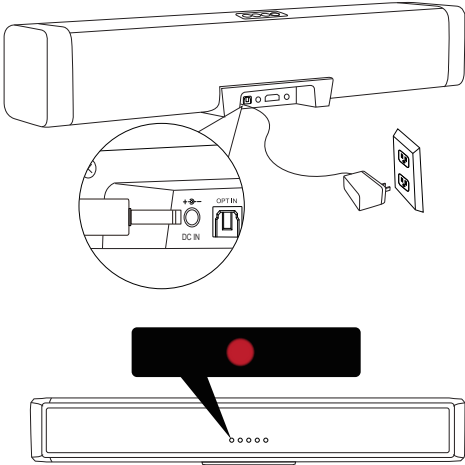

**Step 3: Powering on the soundbar and enter into Bluetooth mode (Led indicator lights on blue)**

**Step 4: Selecting the appropriate method to connect the soundbar to your TV based on its outputs (Optical Preferred)**

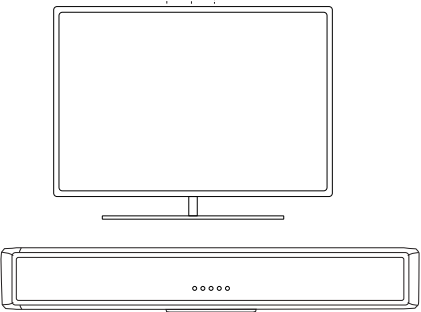
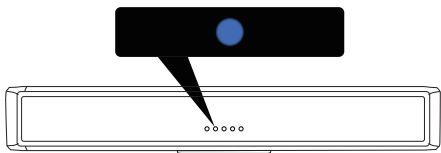
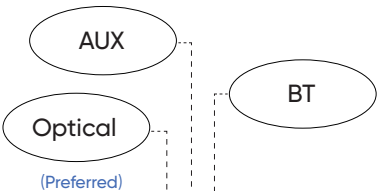
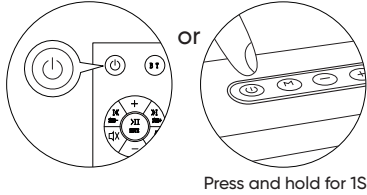

# Optical Connection

(Preferred)

**Step 1: Removing the Protective Caps from both ends of the optical cable**

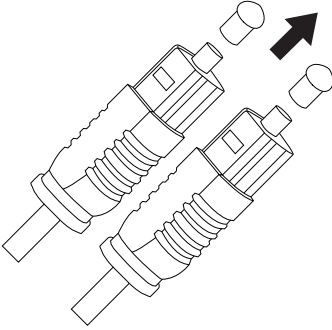

**Step 2: Connecting with Optical Cable**

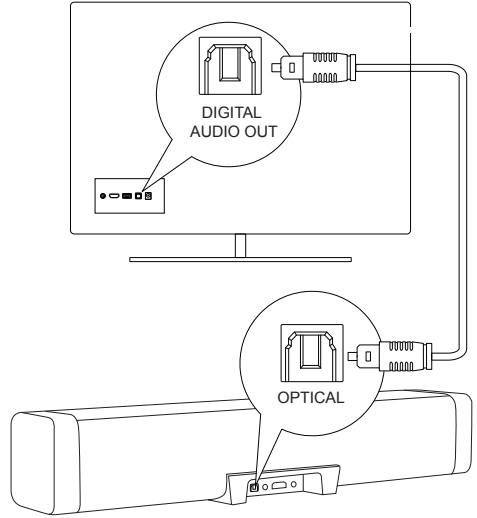

**Step 3: Switching Soundbar to Optical Mode**

Press M button on top of soundbar or OPT button on remote to switch to OPT mode.

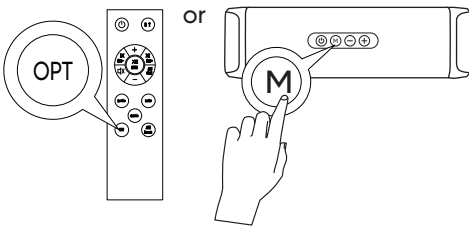

Indicator Lights on Purple

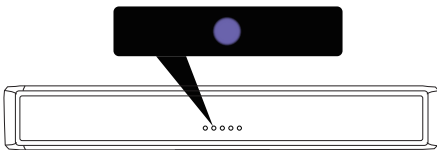

**Step 4: Setting TV Sound Output to Optical**

Settings>Sound>Sound Output> Optical

Different TV brands have varying setup procedures, please refer to your TV's owner's guide for the appropriate setup instructions.

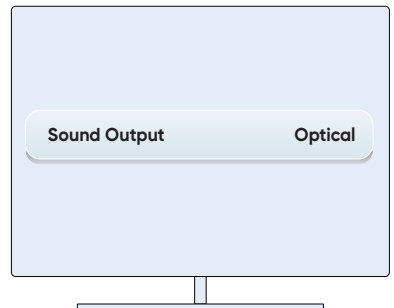

# Optical Connection

(Preferred)

## Step 5: Changing Digital Audio Output format to PCM/Stereo Sound

Settings > Sound > Expert Settings > Digital Output Audio Format > PCM/Stereo Sound

Different TV brands have varying setup procedures, please refer to your TV's owner's guide for the appropriate setup instructions.

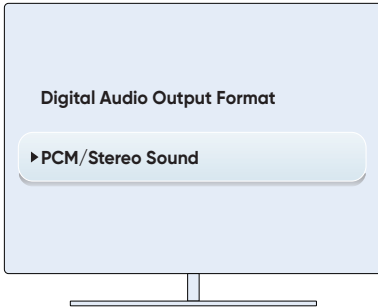

## Step 6: Disabling the Dolby/DTS of TV

To avoid silent or noisy output from the soundbar, please disable the Dolby/ DTS on your TV.

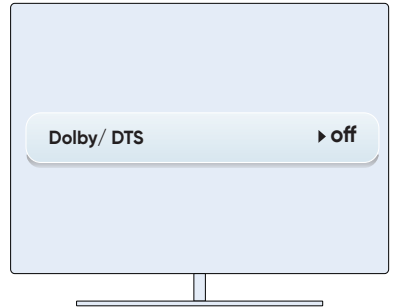

## Step 7: Disabling the Dolby/DTS on Streaming APP

To avoid silent or noisy output from the soundbar, please disable the Dolby/ DTS on streaming APP like Netflix, Amazon Prime Video, HBO, Hulu, Youtube.etc.

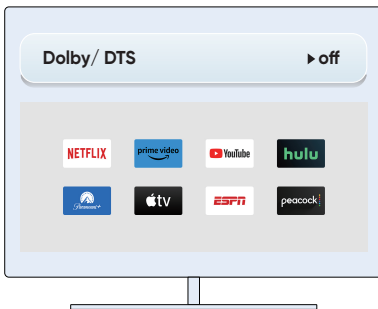

# AUX Connection

## Step 1: Connecting the Audio Cable

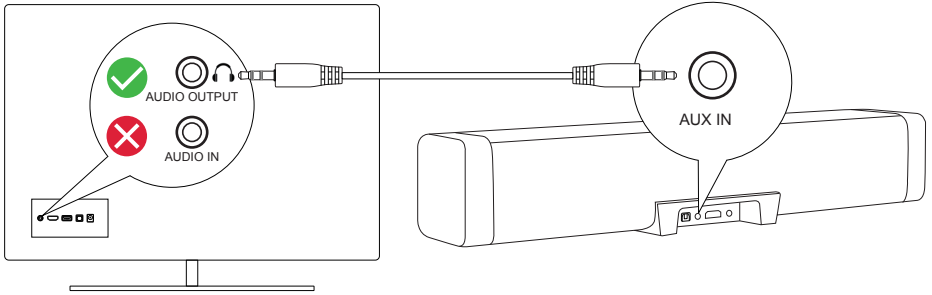

## Step 2: Switching the Soundbar to AUX Mode

Pressing M button on top of soundbar or AUX button on remote to switch to AUX mode.

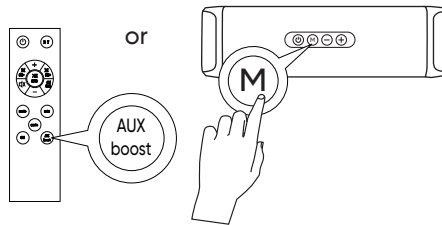

Indicator Lights on Green

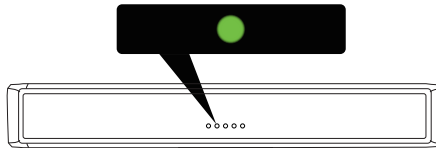

# Bluetooth Connection

Please make sure that your audio source devices are built with Bluetooth transmitter/output like smartphones, TVs and PCs, rather than a Bluetooth receiver/input like Bluetooth headphones, record players with speakers and Bluetooth speakers etc.

## Step 1: Switching the Soundbar to Bluetooth Mode

Pressing M button on top of soundbar or BT button on remote to switch to BT mode.

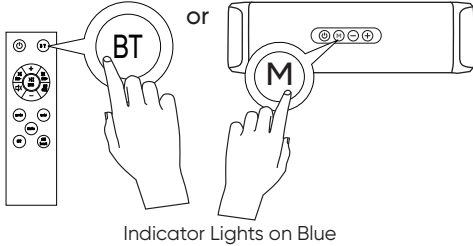

## Step 3: Indicator Light Instructions

The blue light blinks quickly means bluetooth is ready for connection;

The blue light blinks slowly means bluetooth is connected while no audio is being played.

## Step 5: Disconnect Bluetooth Quickly

If you want to connect another Bluetooth device, please press and hold BT button or M button on soundbar for one second to disconnect bluetooth from the current device.

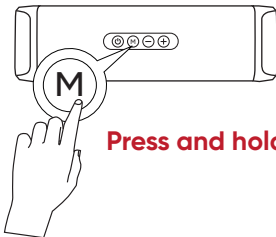

**Press and hold 2S**

## Step 2: Connecting Devices via Bluetooth

Turn on the Bluetooth feature and select SineAudio DSXXXX V1.X from your device list.

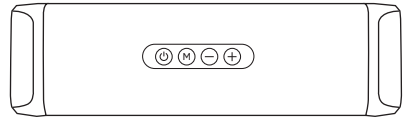
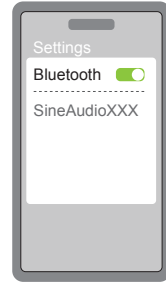

## Step 4: If Audio and Video Out of Sync

If the audio is not synchronized with the video in Bluetooth connection mode, you can try adjusting the audio output delay in your TV settings. (Depends on your TV)

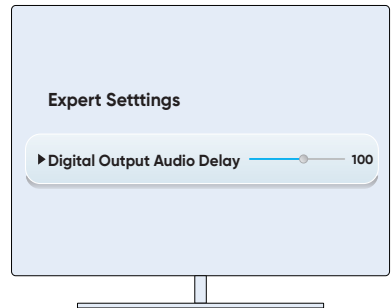

**(Refer to your TV's manual for more information)**

**Step 6: Please max the volume of TV or other audio sources, and then adjust the volume of soundbar**

# Remote Compatibility

## 1: How to Pair **Fire TV Remote** with Soundbar Remote

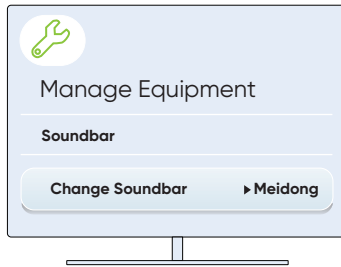

If you are using a Fire TV stick or Fire TV cube, follow these steps to control the speakers with your TV remote: **Set>Equipment Control>Manage Equipment>Soundbar>Change Soundbar>Meidong**

## 2: Remotes compatible with **Roku box or Roku TVs** are provided for free

Please contact us via after sales email [support@sineaudio.com.cn](mailto:support@sineaudio.com.cn) and let us know which remote you need (remote for Roku TV or Roku box) and the brand of your TV.

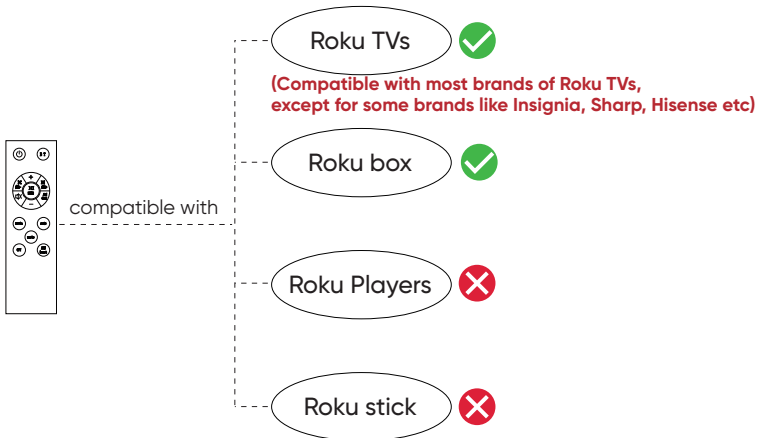

## 3: The remote control is compatible with **GE UltraPro and Philips universal remotes** that support code list 6 (code: 3106)

The remote control is also compatible with **RCA universal remote** that Revision Number is R341U1 (code: 87164)

**Make sure your Universal Remote Control supports soundbar and select the correct model and version. Please contact your Universal Remote Control seller for details**

# Troubleshooting

**1: It is recommended that the volume of the audio source set greater than 50%, and then adjust the volume of soundbar.**

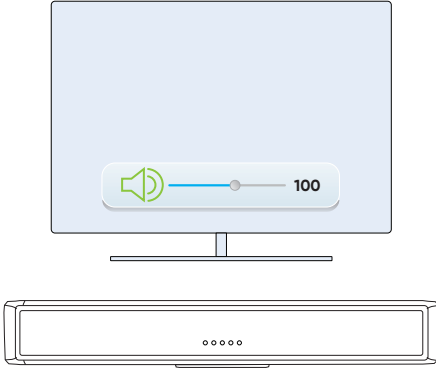

**2: Can't Power On**

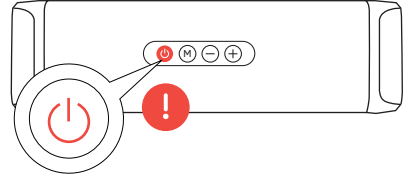

① Please put new batteries into remote, and if it does not work either, please try power button on soundbar.

② Please check whether the power-on button on the soundbar is stuck, or the power adapter is properly plugged into socket.

③ Please contact us via after sales.

**Email: [support@sineaudio.com.cn](mailto:support@sineaudio.com.cn)**

**3: Static and Noise**

All set up while the soundbar has no sound, or the soundbar has only static noise



① Soundbar does not support Dolby and DTS, please kindly disable the Dolby and DTS on both of your TV and video streaming apps like Netflix, Amazon Prime Video, HBO, Hulu, Youtube etc.

② Please try setting digital audio output format to PCM or Stereo.

③ In order to reduce the bottom noise at low volume, please do not minimize the volume of the audio source, it is recommended that the volume of the audio source set greater than 50%, and then adjust volume of soundbar.

④ Make sure that the cables are fully and properly plugged into TV and soundbar.

⑤ Contact us: **[support@sineaudio.com.cn](mailto:support@sineaudio.com.cn)**

**4: Sound Quality Issues**

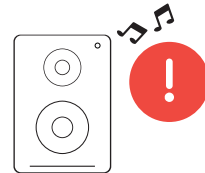

All set up while the soundbar has no sound, or the soundbar has only static noise.

① If you feel the bass is too heavy or the vocals are not enough, press the music or news button on the remote control.

② If distortion or sound quality problems occur, please contact our customer service in time. (**[support@sineaudio.com.cn](mailto:support@sineaudio.com.cn)**)



# Troubleshooting

## 5: Remote Stops Working

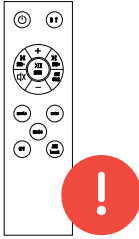

- ① Please contact us via: (support@sineaudio.com.cn) to get a free replacement remote control. (The remote does not come with batteries)
- ② The IR code of the remote control is not compatible with universal remotes or TV remotes. (The remote is compatible with Fire TV remote by choosing "Meidong" as brand of soundbar).

## 7: Stops Working

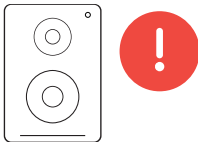

The product comes with a complimentary one-year replacement policy.

If you experience any issues or if the product you received stops working within a year, please reach out to our customer service team for a free replacement.

[support@sineaudio.com.cn](mailto:support@sineaudio.com.cn)

## 6: Bluetooth Connection Issues



- ① Please make sure the soundbar is not connected with any other Bluetooth devices. If the soundbar is connected with smart phone via bluetooth, you will have to press and hold BT on remote for one second to disconnect and then connect with TV again.
- ② More problems please contact us via: [support@sineaudio.com.cn](mailto:support@sineaudio.com.cn)
- ③ Optical cable is recommended to connect with your TV as Bluetooth connection may cause audio delay.
- ④ If the Pause/Start/Mute button is not working under Bluetooth mode, It is probably due to that the source devices do not support Bluetooth AVCRP protocols.

## 8: Three Sound Effects

	Treble	Vocal	Bass	Virtual Surround
Movie	+	-	Deep	++
Music	-	+	Powerful	+
News	-	+++	Weak	-

Three sound effects are designed for three different scenarios to ensure that these effects sound good in their respective applications.

We minimized the differences between them because if the differences were significant, it could result in either low volume due to attenuation or high distortion due to excessive enhancement.

If you have any comments or suggestions, please contact us, we will continue to optimize and improve our sound algorithms!

[support@sineaudio.com.cn](mailto:support@sineaudio.com.cn)